



Popular Solutions

Cabins & Interior Materials





BEST PRODUCT
RANGE IN THE WORLD



EXPERTS IN
SPECIAL PROJECTS



WORLD CLASS
DESIGN



RECORD FAST
DELIVERY FOR
STANDARD
PRODUCTS

Popular Choices	
Exceptional Solutions	02
Cabins Collection	05
Interior Materials	21
Operating Panels	27
World Class Design	32
Customised Solutions	33



Popular choices exceptional solutions

We present you a selection of solutions that were chosen the most over the years and became your favourites. Our best sellers withstood the test of time and proved their value even in the most demanding projects.

When choosing a KLEEMANN lift, you have the control. Pick from futuristic, modern, classic cabins, and create your ideal design with ceilings, floors, walls, handrails, and operating panels.

These parts are also available as components, giving the option of modernisation for pre-existing lifts.

Start your journey and design your cabin through our interactive virtual showroom designyourlift.com.

All popular options are in compliance with EN81.20





CABINS COLLECTION



CLASSIC A310

The KLEEMANN Classic Athena A310 cabin is one of the most popular choices for a practical but elegant lift solution. Combining multiple design tools, create a cabin to your own design specifications and take advantage of a wide range of laminate walls, floor and ceiling options.

A great choice for residential uses and private residences, this cabin presents a versatile and cost-effective solution.



A310 | 1

Wall HP Laminate DU 8110
Floor Rubber 6801
Handrail K3
Ceiling O55

All options are in compliance with EN81.20

Colours may differ slightly from those shown in the manual owing to the limitations of the printing process



A310 | 2

Wall HP Laminate AB 383
Floor Rubber 6727
Handrail K2
Ceiling O3

A310 | 3

Wall HP Laminate DU 1715
Floor Rubber 6768
Handrail K2
Ceiling O14

WALL FINISHES A310
HP Laminate

AB 659	AB 383	DU 1715	DU 5410
AB 1306	HD 2228	DU 6254	DU 8110
HD 2307	HD 2416	HD 2982	MT 2042

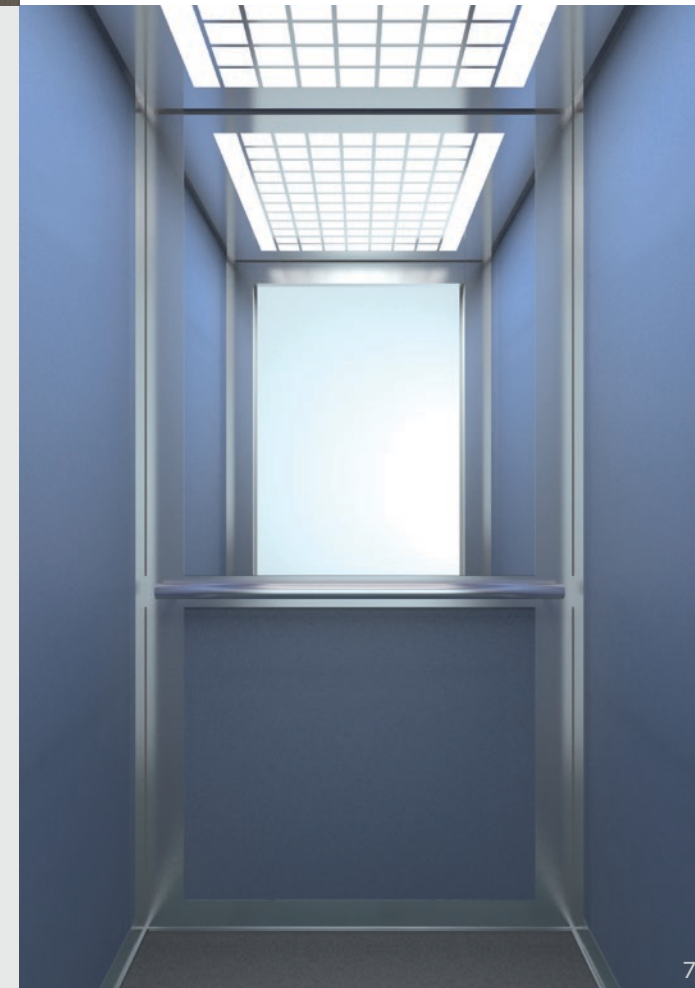



CLASSIC

A510

Sophistication and intellectual design define the KLEEMANN Classic Athena A510 cabin.

Available in a range of wooden walls and featuring elegant stainless steel detailing, such as the classic combination of polished oak veneer and stainless steel.

This cabin is ideal for commercial uses that demand a touch of finesse.



A510 | 1

Wall Wood veneer 10.32 (fire retardant)
Floor Artificial granite Regal White
Handrail K1
Ceiling O10

All options are in compliance with EN81.20

Colours may differ slightly from those shown in the manual owing to the limitations of the printing process

A510 | 2

Wall Wood veneer 10.94 (fire retardant)
Floor Artificial granite Regal Beige
Handrail K1
Ceiling O3

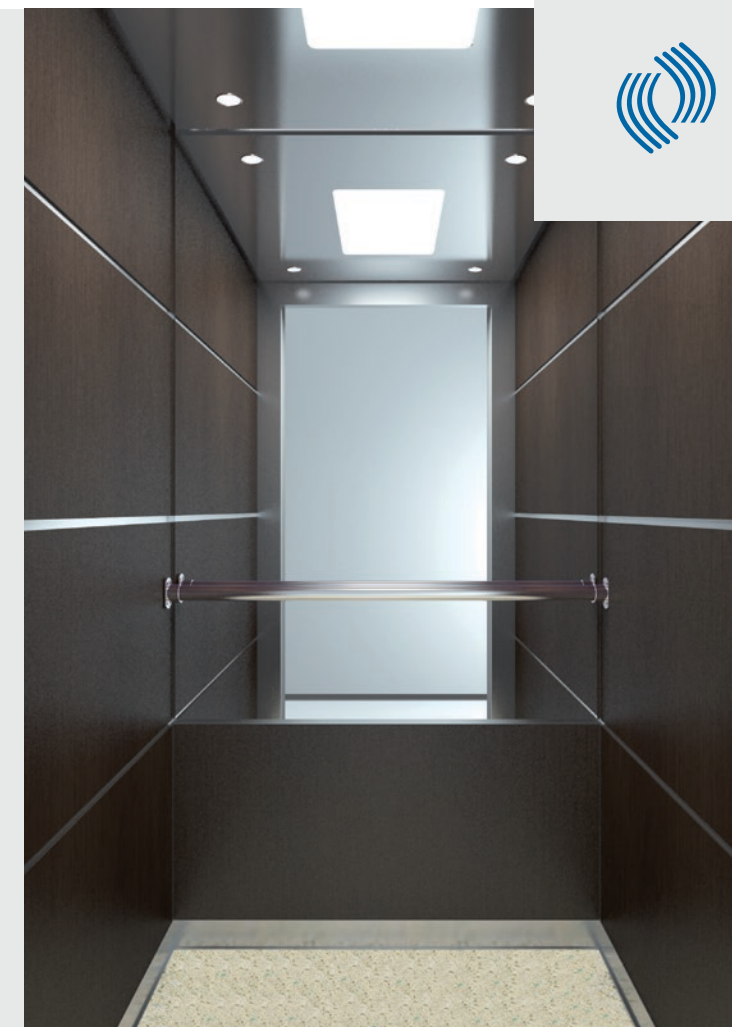

A510 | 3

Wall Wood veneer 10.66 (fire retardant)
Floor Ceramic tile Greek Pentelikon
Handrail K1
Ceiling O15

WALL FINISHES A510

Wood veneer (fire retardant)



10.32 10.94



10.66 10.96





MODERN
LIFE

L310

The KLEEMANN Modern Life L310 cabin offers durability, simplicity and value for money. An ideal choice for all type of buildings, the popularity of this cabin lies in its functional but elegant design.

Offering a range of ceiling and lighting solutions and built to last, this cabin is sure to complement the aesthetic and purpose of a range of commercial buildings



L310 | 1

Wall Stainless steel Satin
Floor Rubber 6768
Handrail K2
Ceiling O14

All options are in compliance with EN81.20

Colours may differ slightly from those shown in the manual owing to the limitations of the printing process



L310 | 2

Wall Stainless steel B/A Linen
Floor Rubber 6727
Handrail K2
Ceiling O55

L310 | 3

Wall Stainless steel Checks
Floor Rubber 6801
Handrail K3
Ceiling O3

WALL FINISHES L310

Stainless steel

	
Satin	Mirror
	
Linen B/A	Checks
	
12LG	





L320 | 1

Wall Skinplate PPS F12
Floor Artificial granite Regal Black
Handrail K3
Ceiling 015

MODERN LIFE

L320

Integrating simplicity and elegance, the KLEEMANN Modern Life L320 cabin is an excellent choice for a range of residential and industrial uses, home solutions, hospitals, hotels and offices.

Offering modest, functional and contemporary design alongside a wide range of materials and possibilities, this cabin provides a versatile and flexible solution for office buildings and institutions.



L320 | 2
Wall Skinplate PPS 13
Floor Ceramic tile Greek Pentelikon
Handrail K3
Ceiling 055

WALL FINISHES L320
 Skinplate

	
A67SMA	A90GTA
	
PPS F12	PPS13
	
PPS93	



L320 | 3

Wall Skinplate A67SMA
Floor Ceramic tile GP5 Nero
Handrail K2
Ceiling 010

Colours may differ slightly from those shown in the manual owing to the limitations of the printing process

All options are in compliance with EN81.20



MODERN LIFE L510

Transform your building with an explosion of colour and immerse your passengers in an uplifting and playful environment. Featuring glass walls to create a clean, fresh space, the KLEEMANN Modern Life L510 cabin is recommended for residential and commercial uses, hospitals and hotels. Choose from a wide range of colours to create a passenger experience that complements the use and aesthetic of commercial and state buildings, institutes and clinics.



L510 | 1

Wall Glass B123W White
Floor Laminate 8096
Handrail K2
Ceiling O3

All options are in compliance with EN81.20

Colours may differ slightly from those shown in the manual owing to the limitations of the printing process









L510 | 2

Wall Glass Y8W Yellow
Floor Artificial granite Regal Black
Handrail K3
Ceiling O55

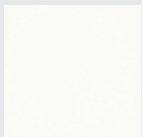
L510 | 3

Wall Glass R3W Red
Floor Laminate 8630
Handrail K2
Ceiling O15

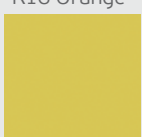
WALL FINISHES L510
Glass

	
B123W White	BL4W Blue
	
K16 Orange	R3W Red mat
	
Y8W Yellow mat	YB9W Green

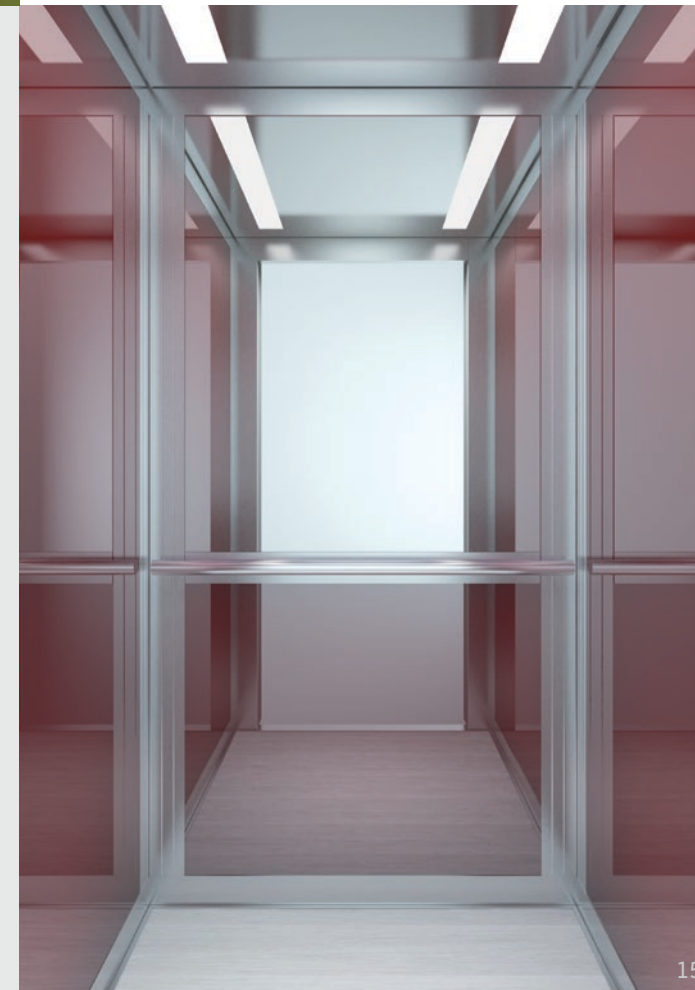



L530 | 1

Wall Stainless steel satin
Floor Artificial granite Regal Black
Handrail K2
Ceiling 015

MODERN
LIFE

L530

Versatility and simplicity define the KLEEMANN Modern Life L530 cabin. Suitable for both commercial and residential uses, this cabin is ideal for luxury private residences, commercial buildings and offices. Choose from a multitude of materials and finishes, from sumptuous interiors of stainless steel mirrors, to sleek contemporary spaces, and create a truly unique space.



L530 | 2
Wall Stainless steel satin
Floor Artificial granite Regal White
Handrail K2
Ceiling 014

WALL FINISHES L530
 Stainless steel

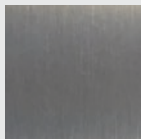
	
Satin	Mirror
	
Linen B/A	Checks
	
12LG	



L530 | 3

Wall Stainless steel B/A Linen
Floor Artificial granite Regal Beige
Handrail K2
Ceiling 055

Colours may differ slightly from those shown in the manual owing to the limitations of the printing process

All options are in compliance with EN81.20



FUTURE
TREND

T120

The exclusive design of the KLEEMANN T120 cabin offers the passenger comfort and style. The affordable design seamlessly fuses contemporary and futuristic elements to deliver a warm and inviting space, ideal for residential uses, home solutions and apartment blocks.



T120 | 1

Wall Melamine K015 PW (fire retardant)
Floor Laminate 8630
Handrail K1
Ceiling 07

All options are in compliance with EN81.20

Colours may differ slightly from those shown in the manual owing to the limitations of the printing process

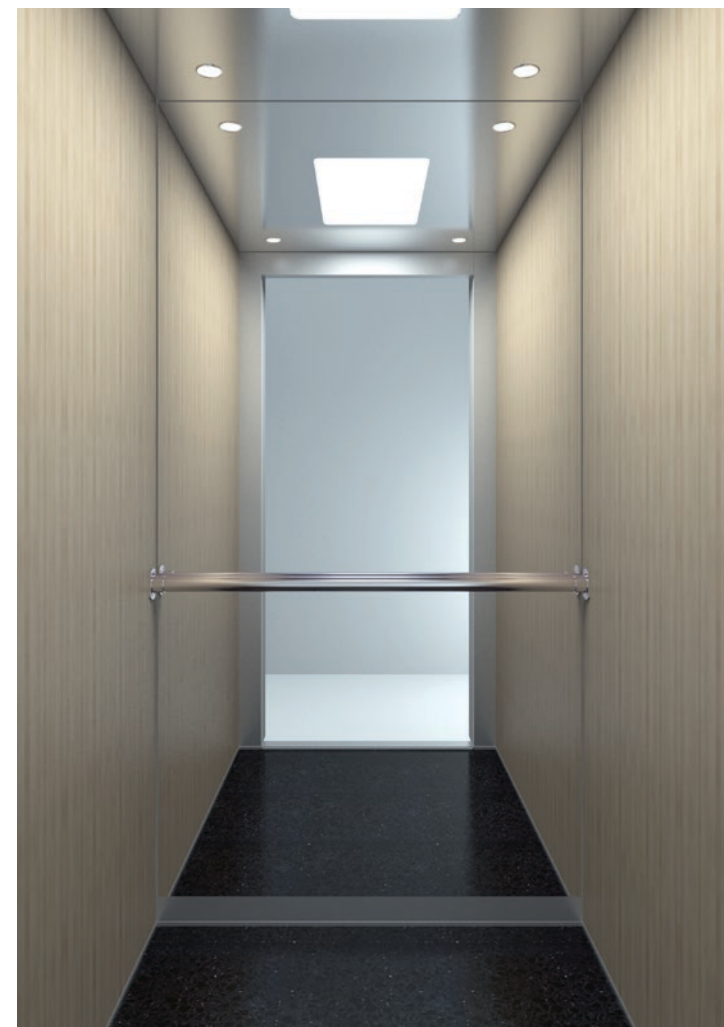

T120 | 2

Wall Melamine K013 SU (fire retardant)
Floor Artificial granite Regal Black
Handrail K1
Ceiling 03

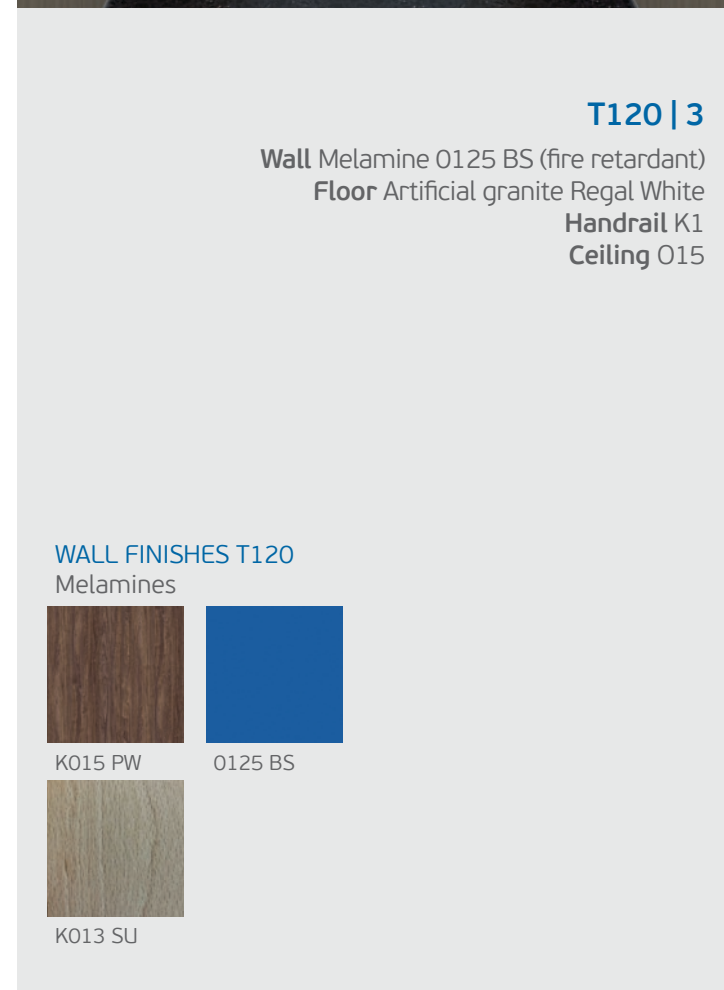

T120 | 3

Wall Melamine 0125 BS (fire retardant)
Floor Artificial granite Regal White
Handrail K1
Ceiling 015

WALL FINISHES T120 Melamines

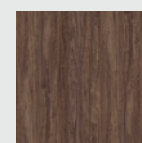

K015 PW



0125 BS

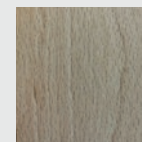

K013 SU



INTERIOR MATERIALS

INTERIOR MATERIALS

Ceilings

Options for ceilings, handrails and floors are available for all cabins.
All options are in compliance with EN81.20.



03



07



010



014



015



055



Handrails

Options for ceilings, handrails and floors are available for all cabins.
All options are in compliance with EN81.20.

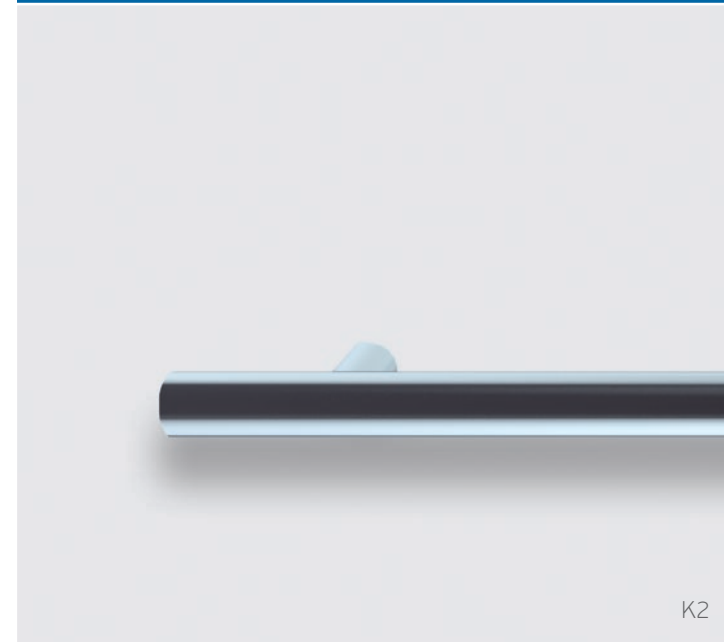

K2

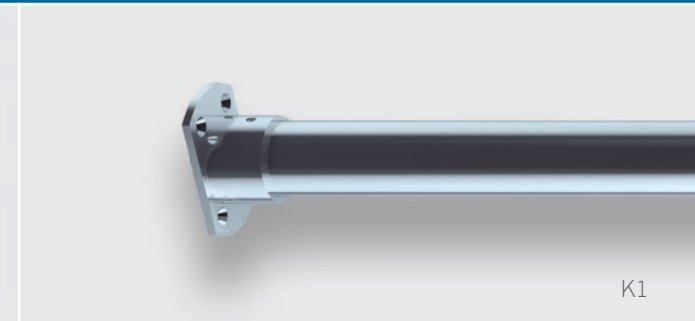

K1



K3 in compliance with EN81.70

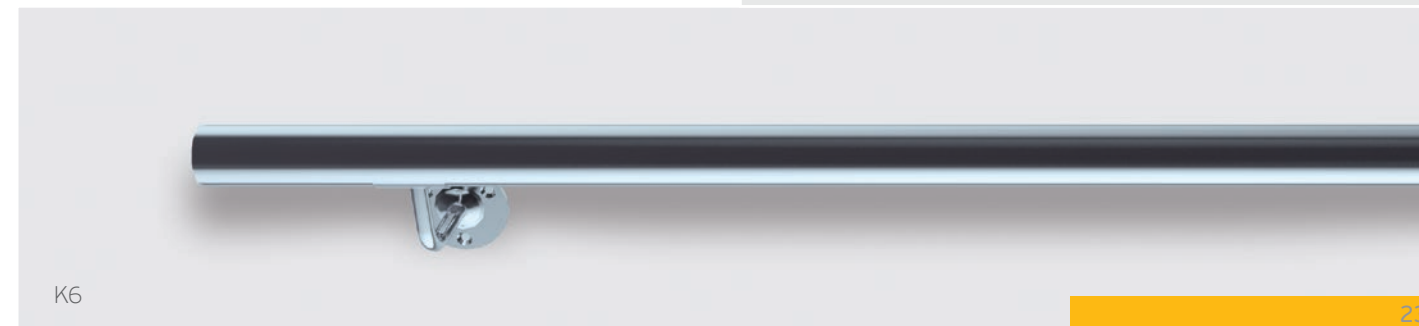

K6

INTERIOR MATERIALS

Floors

Options for ceilings, handrails and floors are available for all cabins.

Rubber

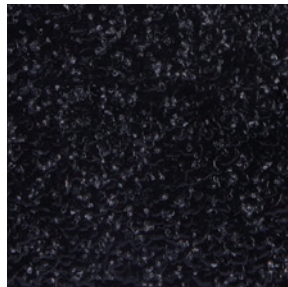

6801

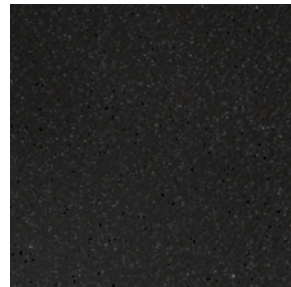

6727

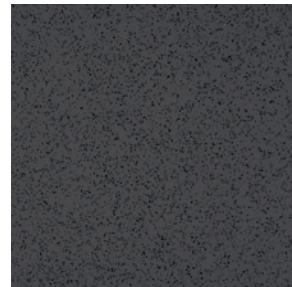

6768



MX19101

Laminates



8096



8630



All options are in compliance with EN81.20

Colours may differ slightly from those shown in the manual owing to the limitations of the printing process



Ceramic Tiles

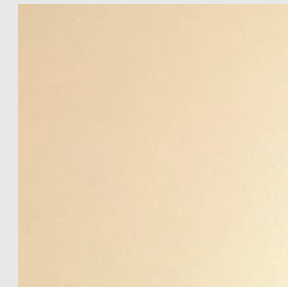

Cream



GP10



GP5 Nero

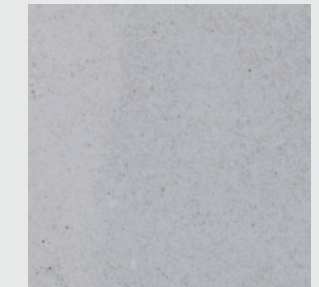

Greek Pentelikon

Artificial Granites

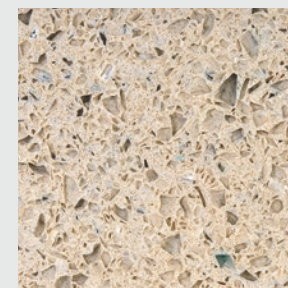

Regal Beige

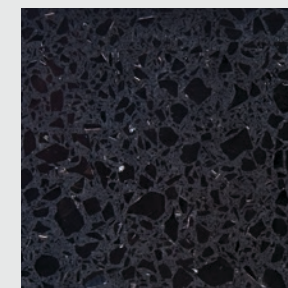

Regal Black

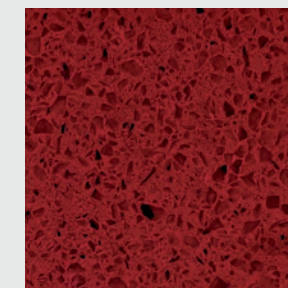

Regal Red



Regal White

All options are in compliance with EN81.20

Colours may differ slightly from those shown in the manual owing to the limitations of the printing process



OPERATING PANELS



OPERATING PANELS

Future Trend Series

FTC Car Operating Panel



FTC Dimensions
(W) 162 mm x (D) 30 mm x (H) 1001 mm

Landing Operating Panels



FTL 001 FTL 002 FTL 101 FTL 102



FTL 001* FTL 002* FTL 101* FTL 102*

FTL Dimensions
(W) 106 mm x (D) 25 mm x (H) 250 mm

* Stainless steel

Indicators



FTHL



FTHL INOX

FTHL Dimensions
(W) 250 mm x (D) 25 mm x (H) 106 mm

Buttons



FTL Stainless steel landing operating panels are also available with any button, VRM-KL and LISA-L displays.

Car Operating Panels

Flush mounted



AKC BES Blue Line* AKC BES* AKC BESL Blue Line* AKC BESL*

Surface mounted



AKC SM BA*

AKC SM BA Dimensions
(W) 225 mm x (D) 35 mm x (H) 1900 mm

AKC BES/AKC BESL Dimensions
(W) 200 mm x (H) 2000 mm

COP's are available with all button types

* full height

COP MODELS	DISPLAY MODELS			
	VRM-KL	LISA-C	SM-04 TL/C (4,3")	LISY-4
AKC-BES	✓	✓		
AKC-BES Blue Line	✓	✓		
AKC-BESL			✓	✓
AKC-BESL Blue Line			✓	✓
AKC-SM-BA full height	✓	✓	✓	✓



OPERATING PANELS

Landing Operating Panels

Flush mounted



AKL 001 002 101 Dimensions
(W) 85 mm x (H) 180 mm

AKL-102 Dimensions
(W) 85 mm x (H) 230 mm

Door frame



Also available with LISA-L and VRM-KL
LOP's are available with all button types

Displays, buttons & indicators

Displays

For Lisa controller



LISA-L



LISA-C



KLEEMANN

LISY 4

Buttons



KLH-42Q



KLH-42R



MT-42



RT-42

Dimensions
KLH 42Q (W) 35 mm x (H) 35 mm
KLH 42R Ø 41 mm
MT-42 (W) 31 mm x (H) 31 mm
RT-42 Ø 30 mm

MT-42 and RT-42
buttons are available
in red and blue

Indicator



P95-902

P95-902 is available with LISA-L, LISA-C,

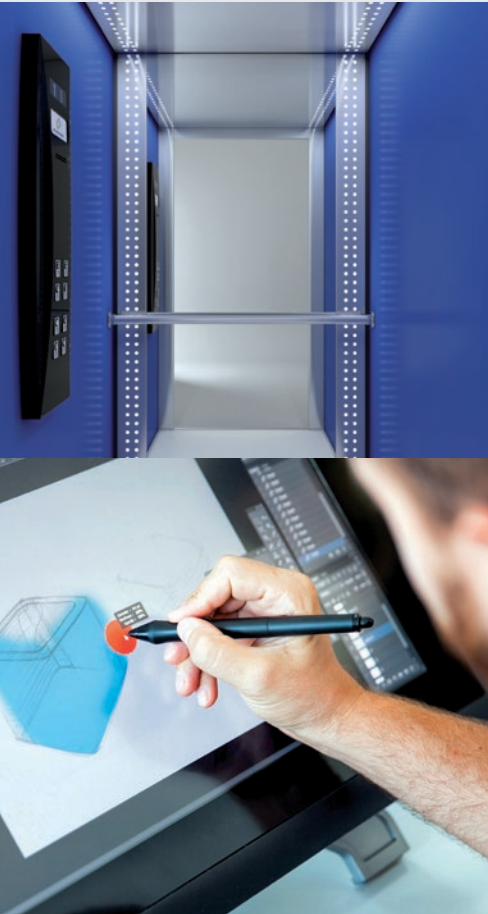

World class design

Since 2007, KLEEMANN has launched its creative research, in cooperation with the industrial designer Andreas Zapatinas. That was the beginning of a new era. Through this rewarding partnership, new technical and aesthetic solutions were explored and developed. Inspired by human needs, KLEEMANN focuses on shaping new space qualities that lift the passenger's mood and stimulates interaction inside the elevator.

Customised solutions

We have a passion to design cabins that combine innovation, class and functionality. With a solution-driven creative force, our highly specialised design team goes beyond standard, creating custom solutions even for the most challenging of your projects. Offering you flexibility and the best of design solutions, we work with you at all stages providing a totally elevated customer experience.

Work with our specialised design team, to create the aesthetics of your ideal cabin



Our cabins

KLEEMANN Design is about life. Going far beyond the elevator design, KLEEMANN cultivates a whole design culture that elevates each and every aspect of its operation. It is a way of thinking, a mindset of innovation. Rather than thinking of the elevator as a box, KLEEMANN Design thinks of it as a unique space in the building and transforms the whole elevator experience into a new value for the people, the bulding, the environment.



kleemannlifts.com

While every effort has been to ensure the accuracy of the information in this brochure, KLEEMANN assumes no responsibility for omissions or typographical errors. Images are for demonstration purposes only. They are not suitable for construction/building purposes, nor feasibility studies.

Copyright © KLEEMANN 2018

